

# UNITE

## Modular Seating



2020 GIZA  
TECHNOLOGIES STUDIO  
(Coming Soon)

**OCI**  
CONTRACT SEATING

# UNITE

## Modular Seating



**Cover Shown As:** (1011) 30 Degree Bench, (1007) 45 Degree Settee Outer Radius, (1012) 45 degree Bench, (1005) 30 Degree Settee Outer Radius, (1017) Inner Table w/Power. May be ordered as Layout #2, please specify fabric choice(s) and options. Seat back shown in Momentum Wanderer, Charcoal. Seats shown in Leslie Jee Catalyst, Mica. Tables shown in OCI Café finish.

**Layout #1 Shown As:** 2 x (1007) 45 Degree Settee Outer Radius, 2 x (1017) Inner Table w/Power, (1005) 30 Degree Settee Outer Radius. Seat Back shown in Momentum Wanderer, Charcoal. Seat shown in Leslie Jee Catalyst, Mica. Table shown in Catalyst Mica with OCI Café top.

**Layout #3 Shown As:** (1002R), 48" Love Seat w/Optional Power and Optional Tablet in OCI Café finish, (1001) Club Chair, (1019) 30x30 Corner Table w/ Optional Power, (1003) 60" Love Seat, (1001L) Club Chair. Seats and Backs shown in Leslie Jee Epiphany Renewal. Table shown in Leslie Jee Epiphany Renewal with OCI Café finish top.

**Layout #4 Shown As:** 2 x (1001C) Club Chair, (1002C) 48" Love Seat, (1010) 60" Bench, (1018) 27" x 27" End Table. Club Chairs shown in Leslie Jee, Venture Nighttide. Love Seat shown in Leslie Jee Motto, Phantom. Bench shown in Leslie Jee, Catalyst Obsidian. Table shown in Leslie Jee Catalyst Obsidian with OCI Café finish top.

**Layout #5 Shown As:** 2 x (1010) 60" Bench, (1014) 27" Square Ottoman, (1009) 48" Bench, (1016) 30" Round Ottoman, 60" Benches shown in Leslie Jee Catalyst, Obsidian. 48" Bench and 27" Square Ottoman shown in Leslie Jee Catalyst, Topaz. 30" Round Ottomans shown in Momentum Interim, Viewpoints, Outlook.

### Available Finishes



**OCI** Sitwell

14815 Radburn Avenue • Santa Fe Springs, California 90670  
562.802.0464 • 866.624.4968 • Fax: 866.624.9662 • [ocisitwell.com](http://ocisitwell.com)

© 2018 OCI Sitwell All Rights Reserved  
\$1.00



LAYOUT #1

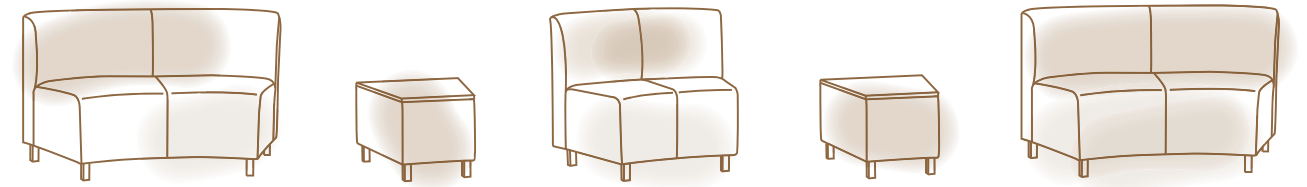

1008 1017 1006 1017 1008

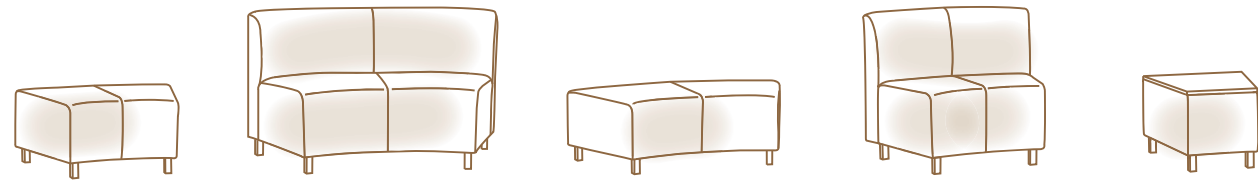

1011 1008 1012 1006 1017



LAYOUT #2



LAYOUT #3

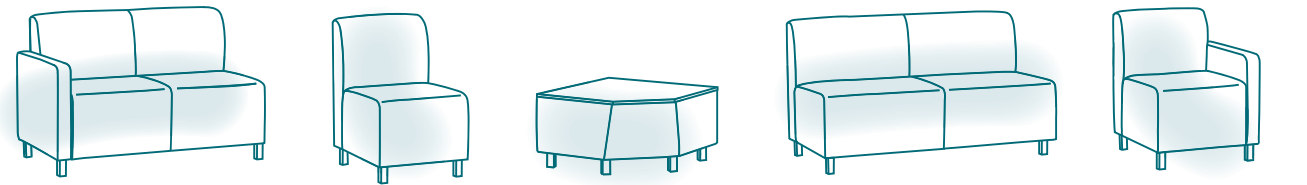

1002R 1001 1019 1003 1001L

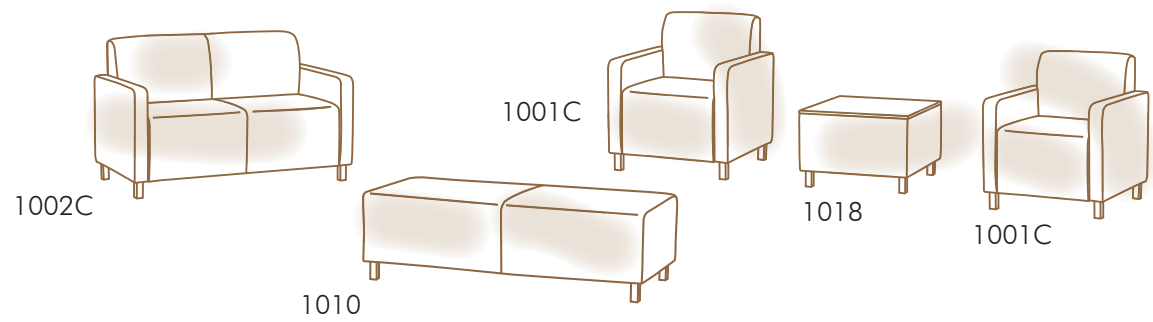

1002C 1001C 1018 1001C 1010



LAYOUT #4

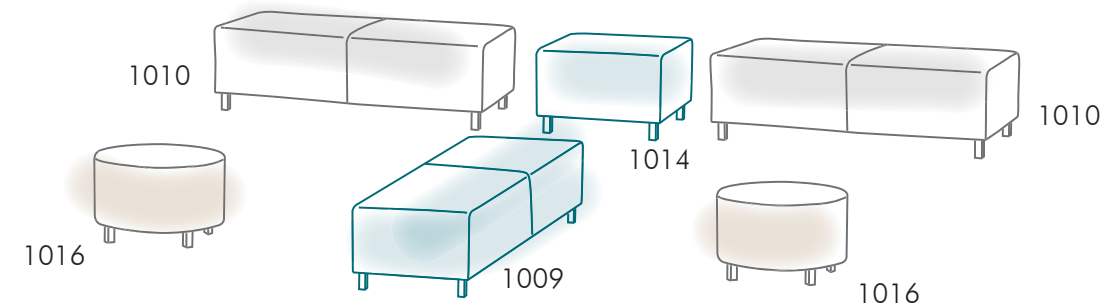

1010 1014 1010 1016 1009 1016



LAYOUT #5

# UNITE Modular Seating



1001C



1001



1001L



1002C



1002



1004

## Rectilinear



1006



1005



1007



1008

## Curvilinear



1012



1016



1010



1019



1009



1014



1017

## Ottomans, Benches & Tables



Chrome Leg  
N/C Option



Black Leg  
N/C Option



Satin Leg  
N/C Option



Wood Leg  
Optional



Table Top Power Supply  
Optional



In Arm Power Supply  
Optional



Ganging Clip  
Optional



Mobile Front Caster and Back Handle  
Optional



# UNITE Modular Seating

## Seating



Dimensions	1001C	1001	1001L/R	1002C / 1003C	1002 / 1003
Seat Height:	18	18	18	18	18
Seat Width:	23	23	23	48 / 60	48 / 60
Seat Depth:	20.5	20.5	20.5	20.5	20.5
Arm Height:	25	n/a	25	25	n/a
Overall Width:	31	23	27	56 / 68	48 / 60
Overall Depth:	27	27	27	27	27
Overall Height:	33.5	33.5	33.5	33.5	33.5

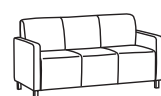

Dimensions	1002L/R / 1003L/R	1003SC	1003S	1003SL/R
Seat Height:	18	18	18	18
Seat Width:	48 / 60	69	69	69
Seat Depth:	20.5	20.5	20.5	20.5
Arm Height:	25	25	n/a	25
Overall Width:	52 / 64	77	69	73
Overall Depth:	27	27	27	27
Overall Height:	33.5	33.5	33.5	33.5



Dimensions	1004	1005	1006	1007	1008
Seat Height:	18	18	18	18	18
Seat Width:	20.5	27.5-37	27.5-38	40-55	40-54
Seat Depth:	20.5	20.5	20.5	20.5	20.5
Arm Height:	n/a	n/a	n/a	n/a	n/a
Overall Width:	27	41	41	59.5	59.5
Overall Depth:	27	27	27	27	27
Overall Height:	33.5	33.5	33.5	33.5	33.5

## Benches

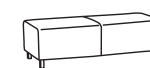
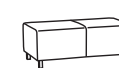

Dimensions	1009	1010	1011	1012
Seat Height:	18	18	18	18
Seat Width:	48	60	27-41	40-59.5
Seat Depth:	27	27	27	27

## Ottomans



Dimensions	1013	1014	1015	1016
Seat Height:	18	18	18	18
Seat Width:	24	27	24	30
Seat Depth:	24	27	24	30

## Tables



Dimensions	1017	1018	1019
Overall Width:	16.25-24.5	27	30
Overall Depth:	27	27	30
Overall Height:	18	18	18